

Power & Energy Monitoring System



1.POWER METERS AND ROGOWSKI COILS	3
1.1. S604 Series - Multifunction power meters	4
S604B - Three phase power meter, BASIC version	5
S604E - Three phase power meter, ENERGY PLUS version	5
S604E-ROG - Three phase power meter, ENERGY PLUS version with Rogowski coils	5
1.2. S711 Series - Multifunction panel power meters	6
S711B - Three phase power meter, BASIC version	7
S711E - Three phase power meter, ENERGY PLUS version	7
S711E-ROG - Three phase power meter, ENERGY PLUS version with Rogowski coils	7
1.3. RC150 Series - Rogowski Coils	8
1.4. Accessories, Programming, Order Codes	10
2. ENERGY COUNTERS	11
2.1. S500 Series - Energy Counters	12
S501-40 - Single phase energy counter 2 wires 1 DIN, MID certified	13
S502-80 - Single phase energy counter 2 wires 2 DIN	13
S504-C - Three phase energy counter 4 wires 4 DIN, built-in communication, MID certified	13
S534 - Three phase energy counter 3/4 wires 4 DIN, MID certified	13
2.2. Accessories, Programming, Order Codes	14



1

POWER METERS & ROGOWSKI COILS



S604 SERIES MULTIFUNCTION POWER METERS

The S604 series includes innovative three-phase network analyzers for the measurement and storage of electrical parameters. All versions for TA standard 1/5 A, for direct link up to 80 A or for Rogowski coils input, enclose the ideal functions for energy management applications. Depending on the model, the device can communicate through the RS485 serial port with ModBUS RTU / ASCII or through the Ethernet port with ModBUS protocol TCP-IP. Onboard Ethernet models is very useful the Web server interface to remotely manage surveys and export logged data for energy audits. The top features of the advanced versions ENERGY Plus are 8 MB for data logs, the recording of harmonics up to 15th and the recording of MIN./AVG/MAX values of all the active and reactive powers.



INSERTION MODE

- Three phase 4 wires
- From 3x400 V to 3x415 V threephase 3 wires
- From 230 V to 240 V single phase



POWER SUPPLY

- Self-Powered models
- Auxiliary supply models



DIGITAL I/O'S

- #1/2 alarm/pulse output
- #1 average values calculation (DMD)



DATA STORAGE

- Active/Reactive Power average values recording (S604B – Basic versions) or All Power MIN/AVG/MAX values di tutte le potenze (S604E Energy Plus versions)
- Up to 8 MB memory for data recording



TYPICAL APPLICATION

- Monitoring system and energy control.
- Individual machine load monitoring.
- Power peak control
- Switchboards, gensets, motor control centers etc.
- Remote metering and cost allocation



SETTINGS

- ENERGY POWER PACK (software)
- Web Server
- Front Key buttons



OPTIONAL COMMUNICATION

- Modbus RTU/ASCII (RS485 port)
- ModBUS TCP-IP (LAN port)



ENERGY COUNTERS AND MEASUREMENTS

- Total counters
- Inductive / capacitive independent counters
- Bidirectional measurement on 4 quadrants for all powers and energies
- Energy efficiency parameters measurement



THD & HARMONICS

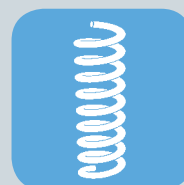

- Current / Voltage THD Values
- Current / Voltage THD Values up to 15th harmonics



CURRENT INPUT

- Version for 1 or 5A CT, for direct connection up to 6A or 80A
- 3 current measurement scales for Rogowski model

ROGOWSKI MULTI-FUNCTION POWER METERS

	S604B	S604E	S604E-ROG
			
	Three-phase Power Meter BASIC version	Three-phase Power Meter ENERGY Plus version	Three-phase power meter kit including nr.1 S604E + nr. 3 Rogowski coils
GENERAL DATA			
Power supply	180..285 Vac line-neutral, Cat III (self powered models) 85..265 Vac, Aux, Cat II (auxiliary powered models)	85..265 Vac, Aux, Cat II (auxiliary powered models)	180..285 Vac line-neutral, Cat III (self powered models) 85..265 Vac, Aux, Cat II (auxiliary powered models)
Max consumption	3,5 VA - 1 W each phase (self-powered models) 1,6 VA - 1 W (auxiliary powered, RS485 models) 4,5 VA - 1,6 W (auxiliary powered, Ethernet models)	1,6 VA - 1 W (auxiliary powered, RS485 models) 4,5 VA - 1,6 W (auxiliary powered, Ethernet models)	1,6 VA - 1 W (auxiliary powered, RS485 models) 4,5 VA - 1,6 W (auxiliary powered, Ethernet models)
Display	LCD, backlighted, 43x29 mm, 3 rows, 4 digit+symbols	LCD, backlighted, 43x29 mm, 3 rows, 4 digit+symbols	LCD, backlighted, 43x29 mm, 3 rows, 4 digit+symbols
Keyboard	3 front button, 1 protected button	3 front button, 1 protected button	3 front button, 1 protected button
Operating temperature	-25..+55°C	-25..+55°C	-25..+55°C
Sinusoidal vibration amplitude	50 Hz ± 0.075 mm	50 Hz ± 0.075 mm	50 Hz ± 0.075 mm
Memory (instrument with communication port)	1 MB	8 MB	8 MB (min/avg/max)
Recordings	AGV values for active and reactive powers	Min/ Avg/Max values for all powers, selectable	AGV values for active and reactive powers
THD & Harmonics	Voltage and current THD values	Voltage and current THD values Voltage and current up to 15th	Voltage and current THD values Voltage and current up to 15th
Apparent Energy Counters	Total counters or separated inductive/capacitive counters	Total counters or separated inductive/capacitive counters	Total counters or separated inductive/capacitive counters
Wiring modes	Three-phase, 4 wires, 3 currents Three-phase, 3 wires, single phase, 2 currents	Three-phase, 4 wires, 3 currents Three-phase, 3 wires, single phase, 2 currents	Three-phase, 4 wires, 3 currents Three-phase, 3 wires, single phase, 2 currents
Front protection degree	IP51	IP51	IP51
Terminals protection degree	IP20	IP20	IP20
Dimension (l x h x w)	72x90x65 mm	72x90x65 mm	72x90x65 mm
Weight	436 g	436 g	436 g
ACCURACY			
Voltage	±0,2% reading 10% FS...FS (FS=full scale value)	±0,2% reading 10% FS...FS (FS=full scale value)	±0,2% reading 10% FS...FS (FS=full scale value)
Current	±0,4% reading in 5% FS...FS	±0,4% reading in 5% FS...FS	±0,4% reading in 5% FS...FS
Power	±0,5% reading ±0,1% FS (PF=1)	±0,5% reading ±0,1% FS (PF=1)	±0,5% reading ±0,1% FS (PF=1)
Frequency	±0,1% reading ±1 digit in 45...65 Hz	±0,1% reading ±1 digit in 45...65 Hz	±0,1% reading ±1 digit in 45...65 Hz
Active Energy	Class 1 according to IEC/EN 62053-21	Class 1 according to IEC/EN 62053-21	Class 1 according to IEC/EN 62053-21
Reactive Energy	Class 2 according to IEC/EN 62053-23	Class 2 according to IEC/EN 62053-23	Class 2 according to IEC/EN 62053-23
COMMUNICATION			
Serial Port	RS485 optoisolated, 300..57.600 bps (optional)	RS485 optoisolated, 300..57.600 bps	RS485 optoisolated, 300..57.600 bps (optional)
Ethernet Port	10/100 Mbps, RJ45 connector (optional)	10/100 Mbps, RJ45 connector	10/100 Mbps, RJ45 connector (optional)
Supported protocols	ModBUS RTU/ASCII (RS485); http, Ntp, Dhcp, ModBUS TCP-IP (Ethernet)	ModBUS RTU/ASCII (RS485); http, Ntp, Dhcp, ModBUS TCP-IP (Ethernet)	ModBUS RTU/ASCII (RS485); http, Ntp, Dhcp, ModBUS TCP-IP (Ethernet)
I/O			
Voltage Input	3x180/310...3x285/495 Vacm Cat III, 300 V (self powered models) 3x10/17...3x285/495 Vac, Cat III 300 V (auxiliary powered models)	3x180/310...3x285/495 Vacm Cat III, 300 V (self powered models) 3x10/17...3x285/495 Vac, Cat III 300 V (auxiliary powered models)	3x180/310...3x285/495 Vacm Cat III, 300 V (self powered models) 3x10/17...3x285/495 Vac, Cat III 300 V (auxiliary powered models)
Current Input	6A (1/5A CT models); 80 A (80 A models)	6A (1/5A CT models); 80 A (80 A models)	3 selectable scales: 500 / 4.000 / 20.000 A by Rogowski Coils
Digital Input	Nr 1 optoisolated active channel (NO COM), DMD synchronization range 80..276 Vac/dc	-	N1 optoisolated active channel (NO COM), DMD synchronization range 80..276 Vac/dc
Digital Output	Nr 1 (RS485 models) / 2 (NO COM models) optoisolated passive channel, IEC/EN 62053-31	Nr 1 (RS485 models) / 2 (NO COM models) optoisolated passive channel, IEC/EN 62053-31	Nr 1 (RS485 models) / 2 (NO COM models) optoisolated passive channel, IEC/EN 62053-31
PROGRAMMING			
Configuration systems	Front key buttons Energy Power Pack software (ModBUS/Ethernet models) Webserver (Ethernet models)	Front key buttons Energy Power Pack software (ModBUS/Ethernet models) Webserver (Ethernet models)	Front key buttons Energy Power Pack software (ModBUS/Ethernet models) Webserver (Ethernet models)
STANDARD			
Certifications	CE	CE	CE
Directives	2006/95/CE, 2004/108/CE	2006/95/CE, 2004/108/CE	2006/95/CE, 2004/108/CE
Norms	EN 61010-1, EN 61010-2-030, EN 61326-1, EN 55011, EN 61000-4-2, EN61000-4-3, EN61000-4-4, EN61000-4-5, EN61000-4-6, EN61000-4-11, EN61000-6-2	EN 61010-1, EN 61010-2-030, EN 61326-1, EN 55011, EN 61000-4-2, EN61000-4-3, EN61000-4-4, EN61000-4-5, EN61000-4-6, EN61000-4-11, EN61000-6-2	EN 61010-1, EN 61010-2-030, EN 61326-1, EN 55011, EN 61000-4-2, EN61000-4-3, EN61000-4-4, EN61000-4-5, EN61000-4-6, EN61000-4-11, EN61000-6-2



S711 SERIES

MULTIFUNCTION PANEL POWER METERS

S711 Series Power Meters Series are characterized by compact front dimensions (96x96 mm) for only 39 mm depth. The S711 models provide bidirectional measurement of four quadrants for all energies and powers and in general the measurement of main parameters required for an effective analysis of consumption.

The Rogowski versions (S711EROG) are available in kit with length sensors 30, 45 and 70 cm. The ENERGY PLUS versions (S711E, S711EROG) allow recording up to 8 MB and 24 selectable parameters between the instantaneous variables for recording MIN / MED / MAX. The S711 Series is available with models supporting communications in ModBUS RTU / ASCII via RS485 port or ModBUS TCP-IP via port Ethernet. The panel meters can also be configured remotely with ENERGY POWER Software PACK or via Web Server



INSERTION MODE

- Voltage measurement up to 600 V, TA 1/5 currents or Rogowski Coils
- Energies and Powers bidirectional measurement all over 4 quadrants



POWER SUPPLY

- Self-Powered models
- Auxiliary supply models



DIGITAL I/O'S

- #1/2 alarm/pulse output
- #1 average values calculation (DMD)



DATA STORAGE

- Up to 24 parameters among instant variables for MIN/Average/Max values
- Up to 8 MB memory for data recording



TYPICAL APPLICATION

- Monitoring system and energy control
- Individual machine load monitoring.
- Power peak control
- Switchboards, gensets, motor control centers etc.
- Remote metering and cost allocation



SETTINGS

- ENERGY POWER PACK (software)
- Web Server
- Front Key buttons



OPTIONAL COMMUNICATION

- Modbus RTU/ASCII (RS485 port)
- ModBUS TCP-IP (LAN port)



ENERGY COUNTERS AND MEASUREMENTS

- Total counters
- Inductive / capacitive independent counters
- Bidirectional measurement on 4 quadrants for all powers and energies
- Energy efficiency parameters measurement



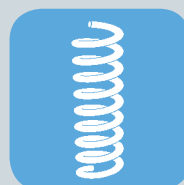

THD & HARMONICS

- Current / Voltage THD Values
- Current / Voltage THD Values up to 15th harmonics



CURRENT INPUT

- Version for 1 or 5A CT, for direct connection up to 6A or 80A
- 3 current measurement scales for Rogowski model

	S711B	S711E	S711EROG
			
	Three-phase Power Meter BASIC version, DIN 96x96 mm	Three-phase Power Meter ENERGY Plus version, DIN 96x96 mm	Three-phase power meter kit including nr.1 S711B + nr. 3 Rogowski coils
GENERAL DATA			
Power Supply	230 Vac / 115 vac (RS485 models) 85..265 Vac, Aux, Cat II (auxiliary powered models)	230 Vac / 115 vac (RS485 models) 85..265 Vac, Aux, Cat II (auxiliary powered models)	230 Vac / 115 vac (RS485 models) 85..265 Vac, Aux, Cat II (auxiliary powered models)
Display	LCD, backlighted, 43x29 mm, 3 rows, 4 digit+symbols	LCD, backlighted, 43x29 mm, 3 rows, 4 digit+symbols	LCD, backlighted, 43x29 mm, 3 rows, 4 digit+symbols
Keyboard	3 front button, 1 protected button	3 front button, 1 protected button	3 front button, 1 protected button
Operating temperature	-25..+55°C	-25..+55°C	-25..+55°C
Sinusoidal vibration amplitude	50 Hz ± 0.075 mm	50 Hz ± 0.075 mm	50 Hz ± 0.075 mm
DMD calculation	DI or window synchronization	DI or window synchronization	DI or window synchronization
Memory (instrument with communication port)	1 MB	8 MB	8 MB
Recordings	AGV values for active and reactive powers	Min/ Avg/Max values for all powers, selectable	Min/ Avg/Max values for all powers, selectable
THD & Armoniche	Voltage and current THD values	Voltage and current THD values Voltage and current up to 15th	Voltage and current THD values Voltage and current up to 15th
Apparent Energy Counters	Total counters or separated inductive/capacitive counters	Total counters or separated inductive/capacitive counters	Total counters or separated inductive/capacitive counters
Wiring modes	Three-phase, 4 wires, 3 currents Three-phase, 3 wires, single phase	Three-phase, 4 wires, 3 currents Three-phase, 3 wires, single phase	Three-phase, 4 wires, 3 currents Three-phase, 3 wires, single phase
Front protection degree	IP51	IP51	IP51
Terminals protection degree	IP20	IP20	IP20
Measuring terminal wire diameter	2,5 mm ² / 14 AWG	1,5.. 6 mm ² (models with CT)	1,5.. 6 mm ² (models with CT)
I/O/Supply/COM terminal wire diameter	1,5 mm ² / 16 AWG	1,5.. 35 mm ² (models with 80A input)	1,5.. 35 mm ² (models with 80A input)
Dimension (lxhwx)	96x96x39 mm	96x96x39 mm	96x96x39 mm
Weight	310 g	436 g	436 g
ACCURACY			
Voltage	±0,2% reading 10% FS...FS (FS=full scale value)	±0,2% reading 10% FS...FS (FS=full scale value)	±0,2% reading 10% FS...FS (FS=full scale value)
Current	±0,4% reading in 5% FS...FS	±0,4% reading in 5% FS...FS	±0,4% reading in 5% FS...FS
Power	±0,5% reading ±0,1% FS (PF=1)	±0,5% reading ±0,1% FS (PF=1)	±0,5% reading ±0,1% FS (PF=1)
Frequency	±0,1% reading ±1 digit in 45..65 Hz	±0,1% reading ±1 digit in 45..65 Hz	±0,1% reading ±1 digit in 45..65 Hz
Active Energy	Class 1 according to IEC/EN 62053-21	Class 1 according to IEC/EN 62053-21	Class 1 according to IEC/EN 62053-21
Reactive Energy	Class 2 according to IEC/EN 62053-23	Class 2 according to IEC/EN 62053-23	Class 2 according to IEC/EN 62053-23
COMMUNICATION			
Serial Port	RS485 optoisolated, 300..57.600 bps (optional)	RS485 optoisolated, 300..57.600 bps	RS485 optoisolated, 300..57.600 bps
Ethernet Port		10/100 Mbps, RJ45 connector	10/100 Mbps, RJ45 connector
Supported protocols	ModBUS RTU/ASCII (RS485)	ModBUS RTU/ASCII (RS485); http, Ntp, Dhcp, ModBUS TCP-IP (Ethernet)	ModBUS RTU/ASCII (RS485); http, Ntp, Dhcp, ModBUS TCP-IP (Ethernet)
MEASUREMENT INPUT			
Voltage Input	Max voltage: 600 Vac max L-L 20/35 VCA (* VT ratio, using VT) Input impedance: >1,3 MOhm Frequency: 45 -65 Hz	Max voltage: 600 Vac max L-L 20/35 VCA (* VT ratio, using VT) Input impedance: >1,3 MOhm Frequency: 45 -65 Hz	Max voltage: 600 Vac max L-L 20/35 VCA (* VT ratio, using VT) Input impedance: >1,3 MOhm Frequency: 45 -65 Hz
Current Input	Max nominal value: 7 A Starting current (Ist): 2 mA CT load: max 0,15 VA per phase Min FFT calculation value: 100 mA * CT ratio	Max nominal value: 7 A Starting current (Ist): 2 mA CT load: max 0,15 VA per phase Min FFT calculation value: 100mA*TA ratio	Nr 3 selectable scales: 500 / 4.000 / 20.000 A by Rogowski Coils
I/O			
Digital Input	Nr1 optoisolated channel for DMD synchronization, range 80..265 Vac/dc	Nr1 optoisolated channel for DMD synchronization, range 80..265 Vac/dc	Nr1 optoisolated channel for DMD synchronization, range 80..265 Vac/dc
Digital Output	Nr 2 optoisolated passive channels for alarms/pulses, NPN/PNP, max 27 Vcc - 27 mA, pulse lenght 50 ± 2 ms, output reaction time 1 s	Nr 2 optoisolated passive channels for alarms/pulses, NPN/PNP, max 27 Vcc - 27 mA, pulse lenght 50 ± 2 ms, output reaction time 1 s	Nr 2 optoisolated passive channels for alarms/pulses, NPN/PNP, max 27 Vcc - 27 mA, pulse lenght 50 ± 2 ms, output reaction time 1 s
Analog Output		Nr 1 optoisolated active channel 0/4..20 mAacc, max load 500 W (model S711E6MODA0)	Nr 1 optoisolated active channel 0/4..20 mAacc, max load 500 W (model S711EROGMOD30A0)
PROGRAMMING			
Configuration systems	Front key buttons Energy Power Pack software (ModBUS/Ethernet models)	Front key buttons Energy Power Pack software (ModBUS/Ethernet models) Webserver (Ethernet models)	Front key buttons Energy Power Pack software (ModBUS/Ethernet models) Webserver (Ethernet models)
STANDARD			
Certifications	CE	CE	CE
Directives	2006/95/CE, 2004/108/CE	2006/95/CE, 2004/108/CE	2006/95/CE, 2004/108/CE
Norms	EN 61010-1, EN 61010-2-030, EN 61326-1, EN 55011, EN 61000-4-2, EN61000-4-3, EN61000-4-4, EN61000-4-5, EN61000-4-6, EN61000-4-11, EN61000-6-2	EN 61010-1, EN 61010-2-030, EN 61326-1, EN 55011, EN 61000-4-2, EN61000-4-3, EN61000-4-4, EN61000-4-5, EN61000-4-6, EN61000-4-11, EN61000-6-2	EN 61010-1, EN 61010-2-030, EN 61326-1, EN 55011, EN 61000-4-2, EN61000-4-3, EN61000-4-4, EN61000-4-5, EN61000-4-6, EN61000-4-11, EN61000-6-2
BUNDLE			
Rogowski Coils	-	-	Nr 3 Rogowski Coils RC150 30, 45, 70 cm (10/14/22 cm internal diameter), 3 m lenght cable



RC150 ROGOWSKI COILS

An air-cored toroidal winding is placed around the conductor, the magnetic field produced by the current induces in the coil a voltage proportional to the rate of change of current. Integrating this voltage the output become proportional to the current (as for a current transformer). Coil length varies from 25 to 300 cm for a cord diameter up to 8 mm



TECHNOLOGY

- The junction point is insensitive to both the position of the internal conductor and to currents carried by external conductors
- Coil and cable shielded against electromagnetic noise



ENGINEERING

- Cross section reduced up to approx. 8mm
- High flexibility



CALIBRATION

- Better than 1% accuracy, even close to the junction point
- Accessible calibration point for easy recalibration, if required

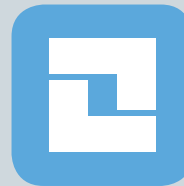

OPTIMAL LOCK

- Secure lock even in presence of vibration and/or pull-ups
- Stable lock ensuring repeatability in measurement



INSTALLATION

- Limited access applications
- Non-Intrusive Current Measurement



TYPICAL APPLICATIONS

- Very high current monitoring
- Harmonics and transients monitoring
- DC ripple measurement
- Power monitoring and control systems
- Measuring devices, lab instrumentation
- Welding machine control

INSTALLATION

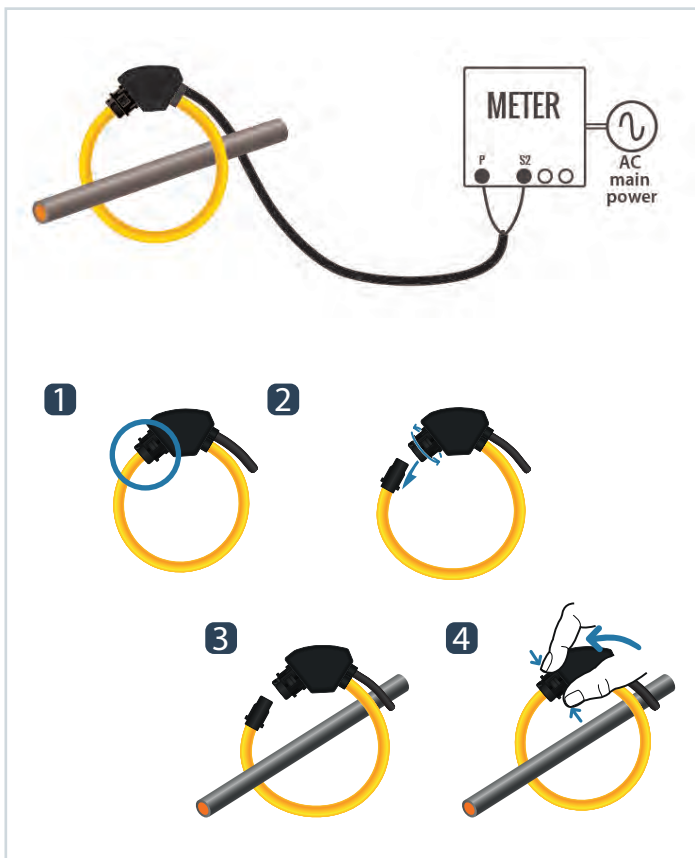

DIMENSION

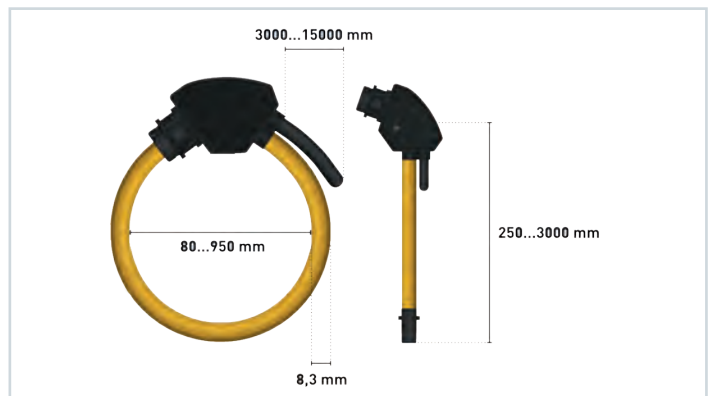

ACCURACY RANGE

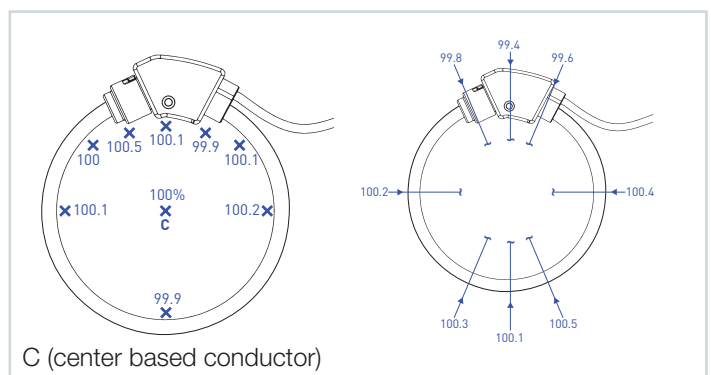

HIGH PERFORMANCE ROGOWSKI COILS

RC150



Rogowski coils have been used for the detection and measurement of electric currents for decades. They are based on a simple principle where an “air-cored” coil is placed around the conductor in a toroidal fashion and the magnetic field produced by the current induces a voltage in the coil. The voltage output is proportional to the rate of change of current. This voltage is integrated, thus producing an output proportional to the current. By using precision winding techniques, especially developed for the purpose, the coils are manufactured so that their output is not influenced by the position of the conductor within the toroid, and to reject interference from external magnetic fields caused, for example, from nearby conductors. Basically, a Rogowski coil current measuring system consists of a combination of a coil and conditioning electronics. Rogowski coil current transducers are used for the AC measurement.

TECHNICAL FEATURES

GENERAL DATA

Coil length	From 25 to 300 cm
Coil diameter	From 8 ±0,2 mm to 57 cm
Cable length	3 m
Lock	Bayonet
Protection Degree	IP67
Material	UL94-V0
Operating temperature	-30..+80°C
Weight	da 150 a 500 g

ELECTRICAL DATA

Output level (RMS)	100 mV / 1 kA @50 Hz (standard)
Transducer resistance	70..900 Ω (RC150)
	300..2.000 Ω (RC190)
Accuracy	Better than ±1% reading valuer (conductor diameter 15 mm)
Frequency	From 40 Hz a 20 kHz
Working voltage	1.000 Vrms CAT III, 600 Vrms CAT IV, pollution degree 2
Test voltage	7.400 Vrms / 1 min

STANDARD

Marking	CE
Norms	EN 61010-1, EN 61010-031, EN 61010-2-031, EN 61010-2-032

APPLICATION NOTE

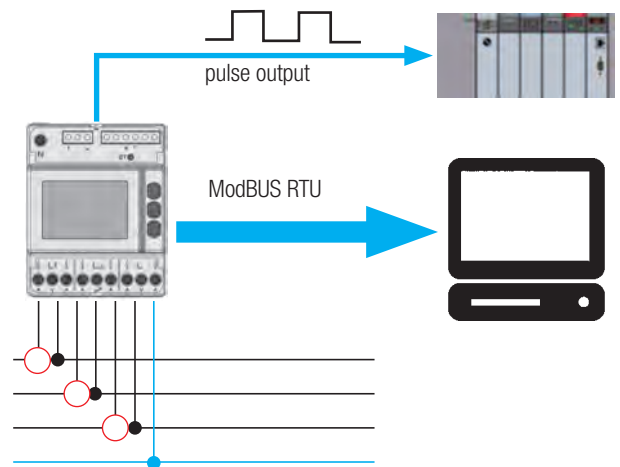

ROGOWSKI COIL KIT / SPARE PARTS

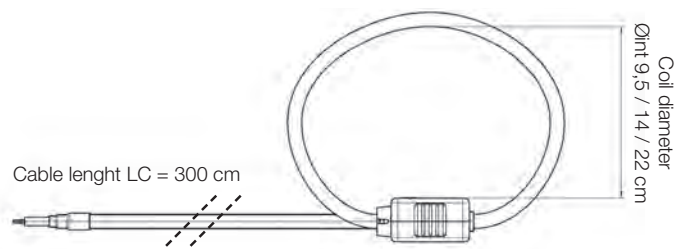

S60B-ROG and S604E-ROG models are supplied as KIT in bundle with 3 Rogowski coils available in 3 different circumferences (30, 45, 70 cm)

ORDER CODE

Code	Description
RC150-025-100-3M	Rogowski Coil L=25cm Øint.8cm,100mV/1KA-50Hz,cable L=3mt.
RC150-035-100-3M	Rogowski Coil L=35cm Øint.11cm,100mV/1KA-50Hz,cable L=3mt.
RC150-040-100-3M	Rogowski Coil L=40cm Øint.12cm,100mV/1KA-50Hz,cable L=3mt.
RC150-060-100-3M	Rogowski Coil L=60cm Øint.19cm,100mV/1KA-50Hz,cable L=3mt.
RC150-090-100-3M	Rogowski Coil L=90cm Øint.28cm,100mV/1KA-50Hz,cable L=3mt.
RC150-120-100-3M	Rogowski Coil L=120cm Øint.38cm,100mV/1KA-50Hz,cable L=3mt.
RC150-180-100-3M	Rogowski Coil L=180cm Øint.57cm,100mV/1KA-50Hz,cable L=3mt.
RC150-RIC-KIT30	Rogowski Coil Kit Spare Parts RC150 L= 30cm Ø int. 9,5 cm, 100mV/1KA-50Hz,cable L=3mt.
RC150-RIC-KIT45	Rogowski Coil Kit Spare Parts RC150 L= 45cm Ø int. 14 cm, 100mV/1KA-50Hz,cable L=3mt.
RC150-RIC-KIT70	Rogowski Coil Kit Spare Parts RC150 L= 70cm Ø int. 22 cm, 100mV/1KA-50Hz,cable L=3mt.
RC150-025-100-5	Rogowski Coil L=25cm Øint.8cm,100mV/1KA-50Hz,cable L=5mt.
RC150-040-100-5	Rogowski Coil L=40cm Øint.11cm,100mV/1KA-50Hz,cable L=5mt.

Kit / coil length	Order Code	Øint / internal diameter	Cable length
30 cm	S604B-ROG-000-30	9,5 cm	300 cm
	S604B-ROG-MOD-30		
	S604B-ROG-ETH-30		
	S604E-ROG-MOD-30		
45 cm	S604E-ROG-ETH-30	14 cm	300 cm
	S604B-ROG-000-45		
	S604B-ROG-MOD-45		
	S604B-ROG-ETH-45		
70 cm	S604E-ROG-MOD-45	22 cm	300 cm
	S604E-ROG-ETH-45		
	S604B-ROG-000-70		
	S604B-ROG-MOD-70		
	S604B-ROG-ETH-70		
	S604E-ROG-MOD-70		
	S604E-ROG-ETH-70		

PROGRAMMING SYSTEM

ETHERNET / MODBUS COMMUNICATION / PROGRAMMING

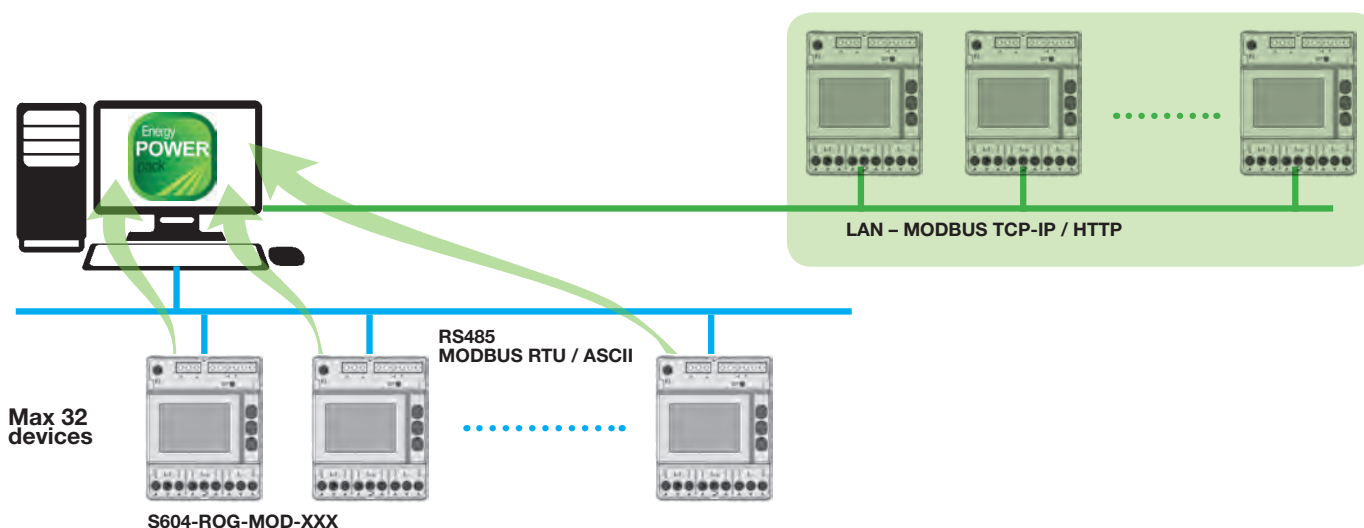

FRONT KEY BUTTONS



Readings, settings and recording are available through front key buttons with 7 display page groups management.



Configuration tool for Energy power meters SERVER S604B and S604E. ENERGY POWER PACK assures reading and visualization of all measurements, it also provides a overall setup of parameters, downloading and converting recording and it manages remote connections



By Web Server it's possible visualizing all device values and associate a recording exportable into a csv file

ORDER CODES

Code	Description
POWER METERS	
S604B-6-MOD	Three phase power meter, BASIC version, for CT/5A, RS485 Modbus,1MB mem. log.
S604B-6-ETH	Three phase power meter, BASIC version, for CT/5A, Ethernet, 1MB mem. log.
S604B-80-MOD	Three phase power meter, BASIC version, 80A-RS485 Modbus,1MB mem. log.
S604B-80-ETH	Three phase power meter, BASIC version, 80A- Ethernet,1MB mem. log.
S604E-6-MOD	Power Meter, Energy PLUS x TA1/5A-RS485 Modbus,8MB log. harmonics
S604E-6-ETH	Power Meter Energy PLUS x TA1/5A-Ethernet,8MB log. harmonics
S604E-80-ETH	Power Meter Energy PLUS 80A-Ethernet,8MB log. harmonics
S604E-ROG-MOD-45	Power Meter Kit Energy PLUS RS485 Modbus,8MB log.harm.+3 Rogowski RC150 L= 45cm Øint.14cm
S604E-ROG-MOD-70	Power Meter Kit Energy PLUS RS485 Modbus,8MB log.harm.+3 Rogowski RC150 L= 70cm Øint.22cm
S604E-ROG-ETH-30	Power Meter Kit Energy PLUS Ethernet,8MB log.harm.+ 3 Rogowski RC150 L= 30 cm Øint. 9,5 cm
S604E-ROG-ETH-45	Power Meter Kit Energy PLUS Ethernet,8MB log.harm.+ 3 Rogowski RC150 L= 45 cm Øint. 14cm
S604EROGETH45-5	Power Meter Kit Energy PLUS Ethernet,8MB log.harm.+ 3 Rogowski RC150 L= 45 cm Øint. 14cm, probes cable 5m
S604EROGETH45-10	Power Meter Kit Energy PLUS Ethernet,8MB log.harm.+ 3 Rogowski RC150 L= 45 cm Øint. 14cm, probes cable 10m
S604E-ROG-ETH-70	Power Meter Kit Energy PLUS Ethernet,8MB log.harm.+ 3 Rogowski RC150 L= 70cm Øint. 22cm
S711B6MOD	LCD 96x96 BASIC Power Meter, TA1/5A-RS485 Modbus,1MB mem. log.,1 DI 2 DO
S711E6MOD	LCD 96x96 Energy PLUS Power Meter, TA1/5A-RS485 Modbus,8MB log.,1 DI 2 DO, harmonics
S711E6MODAO	LCD 96x96 Energy PLUS Power Meter, TA1/5A-RS485 Modbus,8MB log.,1 DI 2 DO 1AO, harmonics
S711E6ETH	LCD 96x96 Energy PLUS Power Meter, TA1/5A-Ethernet,8MB log, 1 DI 2 DO, harmonics
S711EROGMOD30	LCD 96x96 Energy PLUS Power Meter Kit, RS485 Modbus,8MB log.,1 DI 2 DO,Arm.+3 Rogowski RC150 L= 30cm Øint.9,5cm
S711EROGMOD45	LCD 96x96 Energy PLUS Power Meter Kit, RS485 Modbus,8MB log.,1 DI 2 DO, harmonics, 3 Rogowski RC150 L= 45cm Øint.14cm
S711EROGMOD70	LCD 96x96 Energy PLUS Power Meter Kit, RS485 Modbus,8MB log.,1 DI 2 DO,Arm.+3 Rogowski RC150 L= 70cm Øint.22cm
S711EROGMOD30AO	LCD 96x96 Energy PLUS RS485 Modbus,8MB log.,1 DI 2 DO 1 AO, harmonics, 3 Rogowski RC150 L= 30cm Øint.9,5cm
S711EROGMOD45AO	LCD 96x96 Energy PLUS Power Meter Kit, RS485 Modbus,8MB log.,1 DI 2 DO 1 AO, harmonics, 3 Rogowski RC150 L= 45cm Øint.14cm
S711EROGMOD70AO	LCD 96x96 Energy PLUS RS485 Modbus,8MB log.,1 DI 2 DO 1 AO, harmonics, 3 Rogowski RC150 L= 70cm Øint.22cm
S711EROGETH30	LCD 96x96 Energy PLUS Power Meter Kit , Ethernet,8MB log.,1 DI 2 DO, harmonics, 3 Rogowski RC150 L= 30 cm Øint. 9,5 cm
S711EROGETH45	LCD 96x96 Energy PLUS Power Meter Kit , Ethernet,8MB log.,1 DI 2 DO, harmonics, 3 Rogowski RC150 L= 45 cm Øint. 14cm
S711EROGETH70	LCD 96x96 Energy PLUS Power Meter Kit, Ethernet,8MB log.,1 DI 2 DO, harmonics, 3 Rogowski RC150 L= 70cm Øint. 22cm
SOFTWARE	
E-POWER PACK	Management software for S604 Series power meters
SOFTWARE	
S117P1	RS232/USB, TTL/USB, RS485/USB asynchronous and optoisolated serial converter
S107USB	RS485/USB optoisolated serial converter, portable version

2**ENERGY
COUNTERS**



S500 Series ENERGY COUNTERS

The new SENECA energy counters for DIN rail mounting cover the most different application requirements for single-phase and three-phase systems.

Available with RS485 Modbus, M-BUS or Ethernet + webserver communication interfaces, the energy counters are compliant with MID (2004/22 / EC Directive) in class B with EN 50470 standard. Equipped with Wide backlighted LCD display for easy consultation of the values of energy and power, the counters also make available the diagnostic function signaling polarity errors in the connection.



M-BUS COMMUNICATION

- European standard (EN 13757-2 physical and link layer, EN 13757-3 application layer) for the remote reading of gas or electricity meters.
- 2-wires connection
- High number of nodes



MID CERTIFICATION

- Fiscal devices
- European Directive 2004/22/EC for measuring instruments
- Supplementary metrology marking



SO OUTPUT / TARIFF INPUT

- Nr. 1 tariff input
- Nr.2 SO output for energy pulse retransmission



COMMUNICATION PROTOCOLS

- External or built-in communication with optical port
- Supported protocols: ModBUS, Ethernet, M-BUS, Konnex



ACCURACY

- Active Energy: class B, EN 50470-3
- Reactive Energy: class 2, IEC EN 62053-23



CONNECTIONS

- For 3 / 4 wires power networks with balanced / unbalanced load
- Current: direct connection or by Current Transformer
- Single phase / Three phase voltage



SETTINGS





- Front keys
- ENERGY MODBUS PACK software tool
- ENERGY M-BUS PACK software tool
- Web Server



TYPICAL APPLICATIONS

- Energy totalization for industrial machinery
- Power consumption remote monitoring
- Measurement of energy generated by renewable sources
- Accounting and billing of power consumptions

ROGOWSKI MULTI-FUNCTION POWER METERS

	S501-40	S502-80	S504C	S534
				
	Single phase energy counter 2 wires 1 DIN, MID certified	Single phase energy counter 2 wires 2 DIN	Three phase energy counter 4 wires 4 DIN, built-in communication, MID certified	Three phase energy counter 3/4 wires 4 DIN, MID certified
GENERAL DATA				
Power Supply	From voltage circuit	From voltage circuit	From voltage circuit	From voltage circuit
Max consumption	1,5 VA - 1 W	7,5 VA - 0,5 W (for each phase)	7,5 VA - 0,5 W (for each phase) - M-BUS version 3,5 VA - 1 W (for each phase) - Modbus/ Ethernet version)	7,5 VA - 0,5 W (for each phase)
Accuracy	Active Energy class 1 according IEC/EN 62053-21 and class B according to EN 50470-3 (MID) Reactive Energy class 2 according to IEC/EN 62053-23	Active Energy class B according to EN 50470-3 Reactive Energy class 2 according to IEC/EN 62053-23	Active Energy class B according to EN 50470-3 Reactive Energy class 2 according to IEC/EN 62053-23	Active Energy class B according to EN 50470-3 Reactive Energy class 2 according to IEC/EN 62053-23
Tariff input		Active optoisolated Voltage range for tariff 2: 80..276 Vac/dc	Active optoisolated Voltage range for tariff 2: 80..276 Vac/dc	Active optoisolated Voltage range for tariff 2: 80..276 Vac/dc
Metrological LED	Meter constant 5000 imp/kWh Pulse length 4±0,1 ms	Meter constant 1000 imp/kWh	Meter constant 10000 imp/kWh Pulse length 10±2 ms	Meter constant 10000 imp/kWh Pulse length 10±2 ms
Reset Counters	Option	Option		Option
Operating Temperature	-25..+55°C	-25..+55°C	-25..+55°C	-25..+55°C
Protection Degree	IP51 (front), IP20 (terminals)	IP51 (front), IP20 (terminals)	IP51 (front), IP20 (terminals)	IP51 (front), IP20 (terminals)
Dimension (lxhxd)	18x90x64 mm	36x90x64 mm	72x90x64 mm	72x90x64 mm
VOLTAGE				
Nominal Values	230 V, 50-60 Hz	230 V 50 Hz 240 V 50 Hz 230 V 50/60 Hz 230..240 V 50/60 Hz	3x230/400..3x240/415 V 50/60 Hz	3x230/400 V 50 Hz 3x240/415 V 50 Hz 3x230/400 V 50/60 Hz 3x230/400..3x240/415 V 50/60 Hz
CURRENT				
Starting current Ist	20 mA	20 mA	2 mA (S504C-6) / 20 mA (S504C-80)	2 mA (S534-6) / 20 mA (S534-80)
Minimum current Imin	250 mA	250 mA	10 mA (S504C-6) / 250 mA (S504C-80)	10 mA (S534-6) / 250 mA (S534-80)
Transitional current Itr	500 mA	500 mA	50 mA (S504C-6) / 500 mA (S504C-80)	50 mA (S534-6) / 500 mA (S534-80)
Reference current Iref (Ib)	5 A	5 A	1 A (S504C-6) / 5 A (S504C-80)	1 A (S534-6) / 5 A (S534-80)
Maximum current Imax	40 A	80 A	6 A (S504C-6) / 80 A (S504C-80)	6 A (S534-6) / 80 A (S534-80)
SO OUTPUTS / ENERGY PULSE EMISSION				
Q.ty / Type	1 passive optoisolated	2 passive optoisolated	Passive optoisolated	2 passive optoisolated
Max Values	27 Vdc - 27 mA	250 Vac/dc - 100 mA	27 Vdc - 27 mA	250 Vac/dc - 100 mA
Pulse lenght	100±0,5 ms	50±2 ms	50±2 ms	50±2 ms
Meter constant	1000 imp/kWh			
COMMUNICATION				
Protocols supported	ModBUS, M-BUS, Ethernet	ModBUS, M-BUS, Ethernet, Konnex	ModBUS, M-BUS, Ethernet	ModBUS, M-BUS, Ethernet, Konnex
Modbus communication	RS485 port, Modbus RTU/ASCII, 30..57600 bps		RS485 port, Modbus RTU/ASCII, 30..57600 bps	
M-BUS communication	EN 1434-3 wired port, M-BUS, 300..38400 bps		EN 1434-3 wired port, M-BUS, 300..38400 bps	
Ethernet communication	10/100BaseT, http, Ntp, Dhcp, ModBUS TCP, 10/100 Mbps, data recording, Web Server		10/100BaseT, http, Ntp, Dhcp, Modbus TCP, 10/100 Mbps, data recording, web server	
Type	External interface / Built-in	External interface	Built-in	External interface
CONFIGURATION				
Programming System	Front key button E-MODBUS-PACK, E-MBUS-PACK	Front key buttons E-MODBUS-PACK, E-MBUS-PACK	Front key buttons E-MODBUS-PACK, E-MBUS-PACK Web Server	Front key buttons E-MODBUS-PACK, E-MBUS-PACK
STANDARD				
Norms	EN 50740-3, IEC/EN 62053-21/23	EN 50740-3	EN 50470-3, EN 62053-23	EN 50470-1, EN 50470-3, EN 62053-23
Certifications	CE, MID	CE, MID	CE, MID	CE, MID

S500 SERIES - PROGRAMMING

FRONT KEY BUTTONS



By front key buttons on all models can be programmed these functions:

- **Page scroll Temporary visualization of secondary values**
- **Access / exit Programming pages**
- **Start / stop / reset partial hour counter**
- **Setting parameters**
- **Display test**

WEBSERVER



All counters S500 Series energy counters - Ethernet or external COM version - have access to a **WEB SERVER** accessible through protected connection. WEB SERVER provides real-time values and recorded data in .csv exportable files.

ENERGY MODBUS PACK



Free download
by
www.seneca.it

Modbus models can be configured through software package **ENERGY MODBUS PACK** downloadable by www.seneca.it.

- **Serial port setting**
- **Search / addition counters**
- **Network parameters configuration for each counter**

ENERGY M-BUS PACK



Free download
by
www.seneca.it

Communication models with M-BUS interface can be configured by the software package **ENERGY M-BUS PACK** downloadable by www.seneca.it.

- **Serial port setting**
- **Search / addition counters network**
- **Parameters configuration network for each meter**

ORDER CODES

Code	Description
ENERGY COUNTERS	
S501-40-0	40A single phase energy counter 2 wires 1 DIN
S501-40-0-MID	40A single phase energy counter 2 wires 1 DIN, MID certified
S501-40-MOD-MID	40A single phase energy counter 2 wires 1 DIN, RS485 ModBUS MID certified
S501-40-MBU-MID	40A single phase energy counter 2 wires 1 DIN, M-BUS, MID certified
S502-80-MOD	80A single phase energy counter 2 wires 2 DIN, RS485 Modbus
S502-80-MBU	80A single phase energy counter 2 wires 2 DIN, M-BUS
S502-80-ETH	80A single phase energy counter 2 wires 2 DIN, Ethernet
S502-80-MID	80A Single Phase Energy Counter, 2 wires, 1 DIN, MID certified
S504C-6-MOD-MID	6A three phase energy counter 4 wires 4 DIN, RS485 Modbus, MID certified
S504C-6-MBU-MID	6A three phase energy counter 4 wires 4 DIN, M-BUS, MID certified
S504C-6-ETH-MID	6A three phase energy counter 4 wires 4 DIN, Ethernet, MID certified
S504C-80-MOD-MID	80A three phase energy counter 4 wires 4 DIN, RS485 Modbus, MID certified
S504C-80-MBU-MID	80A three phase energy counter 4 wires 4 DIN, M-BUS, MID certified
S504C-80-ETH-MID	80A three phase energy counter 4 wires 4 DIN, Ethernet, MID certified
S534-6-MID	6A three phase energy counter 3/4 wires 4 DIN, MID certified
S534-80-MID	80A three phase energy counter 3/4 wires 4 DIN, MID certified
SOFTWARE	
E-MODBUS PACK	Management software for S500 Series energy counters with Modbus / Ethernet communication
E-M-BUS PACK	Management software for S500 Series energy counters with M-BUS communication
ACCESSORIES	
S117P1	RS232-TTL-RS485/USB serial converter, portable version
S107USB	RS485/USB optoisolated serial converter, portable version
S107MBU	USB - M-BUS converter, portable version
S500-MOD	RS485 Modbus RTU optical interface module



CONTACT AND INFORMATION

Address

Headquarter: Via Austria 26 - 35127 Padova (I)
Tel. +39 049 8705 359 (408)
Fax +39 049 8706287

Web

Automation Products: www.seneca.it
Tech Support: www.seneca.it/supporto

E-mail

General information: info@seneca.it
Sales Office: sales@seneca.it
Quality Management: qualita@seneca.it
Product technical support: support@seneca.it

Follow us on Social Media

